

FULL INVERTER POOL PUMP

ENERGY
EFFICIENT



Neptune
for swimming pools

By **Pool
Pro**

X-PRO

UP TO **15x**
MORE ENERGY
EFFICIENT**

OVER
50%
QUIETER[^]

DC
BRUSHLESS
MOTOR

Wi-Fi
CONTROL

★ ★ ★ ★ ★ ★
6 STAR ENERGY RATING



INVERSilence Tech

SCAN FOR
MORE INFO



Neptune X-Pro Full Inverter Pool Pumps are designed for exceptional energy efficiency and super-quiet operation.

Enjoy total control with a real-time power consumption display and a sleek, intelligent full touch controller.



INVERSilence[®] Tech

Full Inverter Technology



Automatically adjusts running capacity between 30~120%.

Volute Hydraulic System



Spiral volute structure lowers water flow turbulence and noise.

F.O.C

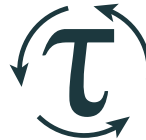

Field Orientated Control efficiently manages the torque and speed of the motor.

DC Brushless Motor

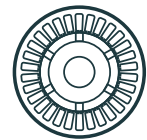

For super-quiet operation, higher efficiency and longer lifespan of the pump.

4 Timers For Daily Operation

With multi speed and multi timer function.

Soft Start Feature

Steadily increases power to maximise energy savings.

External Control

RS485 Modbus and Digital Input: Allows the pump to be operated by other equipment.

Skimmer Mode

Increases water flow to boost the skimming of surface debris for a cleaner pool.

Up To 15x More Energy Efficient^{**}

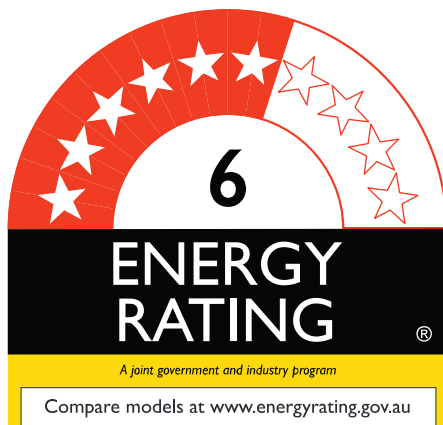

Detachable Controller Cover

A sleek, durable cover providing both water and sun protection for the controller.



Intelligent Full Touch Controller

Easily control and monitor the pump's operation.



AI/MI Mode:

- Auto Inverter Mode: Automatically detects system pressure and adjusts the motor speed to reach the set flow.
- Manual Inverter Mode: Adjust the running capacity manually according to different application needs.



Adjustable flow rate reading.



Real-time power consumption reading.



Real-time running capacity reading.



One touch backwash.



Over 50% Quieter[^]

Quiet operation down to 33 dB.



Whisper

30 dB



Neptune X-Pro Pool Pump

33 dB



Washing Machine

60 dB



Single Speed Pool Pump

70 dB



Wi-Fi Connectivity

Seamlessly connect to Wi-Fi for smart functionality and effortless management.



Dedicated Mobile App

Manage your pool pump efficiently with the dedicated mobile app. Control your pool pump anywhere, any time.



Performance Curves

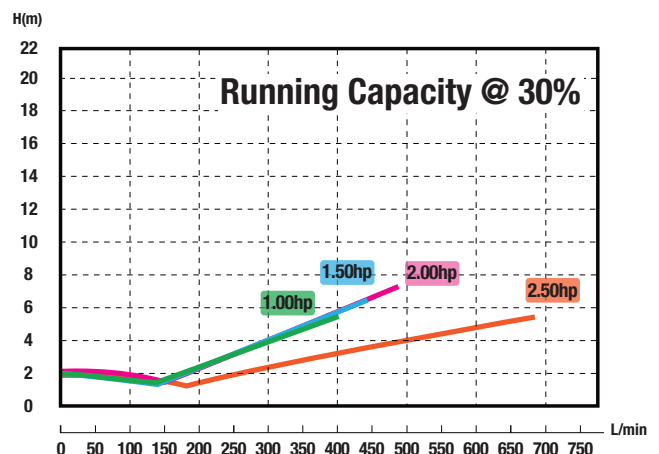
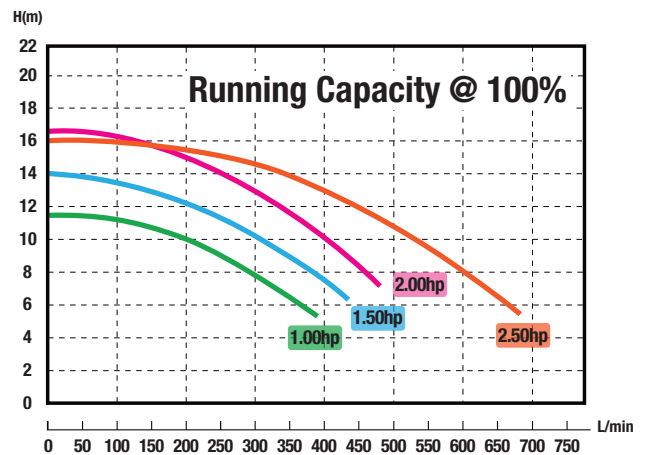
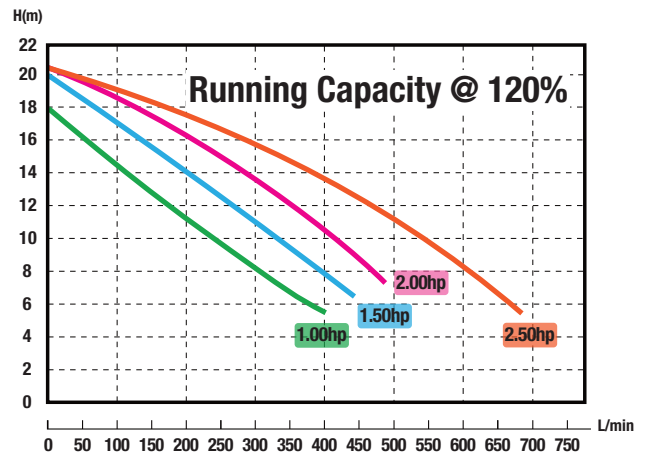

TECHNICAL INFORMATION / PERFORMANCE DATA

Model	Input Power (kW)	Input Power (hp)	Voltage (V/Hz)	Current (A)	Max Flow Rate (L/min)	Flow Rate @ 8m Head (L/min)	Flow Rate @ 10m Head (L/min)
NPX1100	0.80	1.00	220-240 / 50/60	3.5	408	312	243
NPX1500	1.05	1.50		5.3	438	393	333
NPX2000	1.40	2.00		6.5	488	470	420
NPX2500	1.75	2.50		8.0	678	603	543

PRODUCT INFORMATION

MOTOR

Type	Permanent Magnet Motor
Variable Speed	3000rpm Rated
IP Rating	IP55
Insulation Class	Class F
Voltage	220V-240V
Frequency	50Hz-60Hz

MATERIALS

Pump Body	PP (Polypropylene) + GF
Impeller	PPO (Polyphenylene Oxide) + GF
O-Ring	EPDM
Barrel Unions	PVC
Seal Stationary Face	SiC
Seal Rotating Face	Graphite
Seal Spring	316L

NOISE LEVELS

Model	30% Running Speed
NPX1100	33.0 dB
NPX1500	35.4 dB
NPX2000	36.3 dB
NPX2500	37.4 dB

Neptune X-Eco Inverter
Pool Pumps Also Available



www.neptunepumps.com.au

PRODUCT DIMENSIONS (mm)

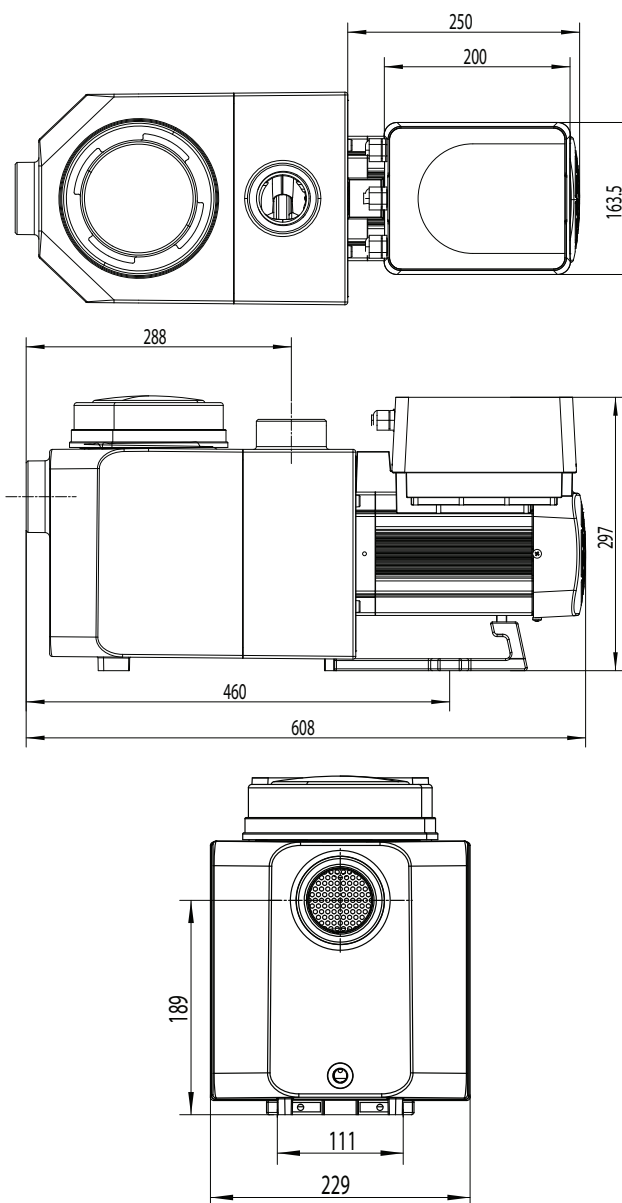

AVAILABLE FROM YOUR LOCAL POOL PRO STOCKIST



**Than regular 1500w single speed pumps. Model NPX1500 @ 8m head.

^Than regular single speed pumps. Model NPX1100 (33 dB).

*Warranty: 4 years limited on all parts and labour. Conditions apply.

