



NEPTUNE X-ECO INVERTER POOL PUMP



INSTALLATION GUIDE AND USER MANUAL



THANK YOU FOR PURCHASING A NEPTUNE INVERTER POOL PUMP.
Please read the manual thoroughly before installing or using the product.
Keep this manual for future reference.

TABLE OF CONTENTS

	Page
SECTION 1: IMPORTANT WARNINGS AND SAFETY INFORMATION	4
SECTION 2: PACKAGING CONTENTS	5
SECTION 3: PRODUCT SPECIFICATIONS	5-6
3.1: PRODUCT DIMENSIONS	5
3.2: TECHNICAL DATA	6
3.3: OPERATING CONDITIONS	6
SECTION 4: INSTALLATION	7
4.1: PUMP LOCATION	7
4.2: PLUMBING THE POOL PUMP	7
4.3: VALVES AND FITTINGS	7
SECTION 5: TOUCHPAD OVERVIEW	8
SECTION 6: START-UP AND OPERATION OF THE PUMP	8-12
6.1: PRE-STARTUP INSPECTION	8
6.2: STARTUP	8
6.3: SELF-PRIMING	9
6.4: SELF-CHECKING	9
6.5: PUMP RUNNING	9
6.6: BACKWASH	9
6.7: RUNNING CAPACITY SETTINGS	10
6.8: TIMER MODE	10-11
6.9: PARAMETER SETTINGS	11-12
SECTION 7: EXTERNAL CONTROLLER (OPTIONAL)	13-14
SECTION 8: MAINTENANCE	14
SECTION 9: PROTECTION MANAGEMENT	14
9.1: HIGH TEMPERATURE WARNING AND SPEED REDUCTION	14
9.2: UNDER-VOLTAGE PROTECTION	14
SECTION 10: TROUBLESHOOTING	15-17
SECTION 11: SCHEMATICS	18
SECTION 12: DISPOSAL	19
SECTION 13: WARRANTY AND PRODUCT REGISTRATION	19



SECTION 1: IMPORTANT WARNINGS AND SAFETY INFORMATION



This manual contains important information about the installation, operation, and safe use of this product. This information should be given to the owner and/or operator of the pool pump. When installing and using the pool pump, basic safety precautions should always be followed. Failure to follow safety warnings and instructions in this manual can result in serious injury and/or damage to your equipment. Read and follow all warning notices and instructions which are included in this manual.

GENERAL WARNINGS

- Read the instructions before installing and using the pool pump.
- Failure to follow these instructions and comply with all applicable codes may cause serious bodily injury and/or property damage and will void the warranty.
- Installers/operators must follow manufacturer's instructions and keep in compliance with national or local standards for installation. Under no circumstances will the manufacturer be held responsible for any outcome incurred by failure to comply with applicable standards or local regulations.
- IEC: This appliance is not intended for use by persons (including children) with reduced physical, sensory or mental capabilities, or lack of experience and knowledge, unless they have been given supervision or instruction concerning the use of this product by a person responsible for their safety.
- Children should be supervised to ensure that they do not play with this product.
- EN/UKCA: This product can be used by children aged from 8 years and above and persons with reduced physical, sensory or mental capabilities or lack of experience and knowledge if they have been given supervision or instruction concerning the use of this product in a safe way and understand the hazards involved. Children shall not play with this product. Cleaning and maintenance shall not be conducted by children without supervision.
- If the supply cord is damaged, it must be replaced by the manufacturer, its service agent or similarly qualified persons in order to avoid a hazard.
- The pump power must be supplied through a residual current device (RCD) with a rated residual operating current ≤ 30 mA.
- Always comply with national and local electrical codes and standards.
- Risk of electrical shock. Connect only to a branch circuit protected by a ground-fault circuit interrupter (GFCI). Contact a professionally trained and qualified electrician if you cannot verify that the circuit is protected by a GFCI.
- To prevent the risk of electrical shock, please connect the ground wire on the motor (green/yellow) to the grounding system.
- This pump is for use with permanently installed in-ground or above-ground swimming pools and may also be used with hot tubs and spas with a water temperature under 50°C. Due to the fixed installation method, this pump is not suggested to be used on above-ground pools that can be readily disassembled for storage.
- This pump is not submersible.
- Never open the inside of the drive motor enclosure.
- Fill the pump with water before starting. Do not run the pump dry. In case of dry run, mechanical seal will be damaged and the pump will start leaking. This will void your warranty.
- Before servicing the pump, switch power OFF to the pump by disconnecting the main circuit to the pump and release all pressure from pump and piping system.
- Never tighten or loosen screws while the pump is operating.
- Ensure that the inlet and outlet of the pump are not blocked by foreign matter.
- This product contains electrical equipment. Dispose of the product in accordance with local regulations.
- Use only genuine replacement parts supplied by the manufacturer for service and repair.

DISCLAIMER

Information in this manual is intended to provide general information on a particular subject(s) in good faith and is not an exhaustive treatment of such subject(s). Its use is beyond the control of the author, contributor, publishers, and distributors and should not be relied upon without consulting your local Professional for comprehensive advice. This manual includes subject(s) that should only be performed by or under the direction and advice of your local Professional and under no circumstances should the manual be used as a substitute for such professionals. No representations or warranties are made that the content, advice, and recommendations in this manual are current, free from errors or omissions, or appropriate for the user's circumstances or abilities. No liability is accepted for any loss suffered as a result of any user's reliance on such content. All information in this document is subject to change at any time without notice.



SECTION 2: PACKAGING CONTENTS

The following items are included in the packaging of the pool pump. Please contact your authorised dealer if any items are damaged or missing.

Inverter Pool Pump x 1

User Manual x 1

Unions x 2

RS485 Communication Cable x 1

SECTION 3: PRODUCT SPECIFICATIONS

3.1: PRODUCT DIMENSIONS

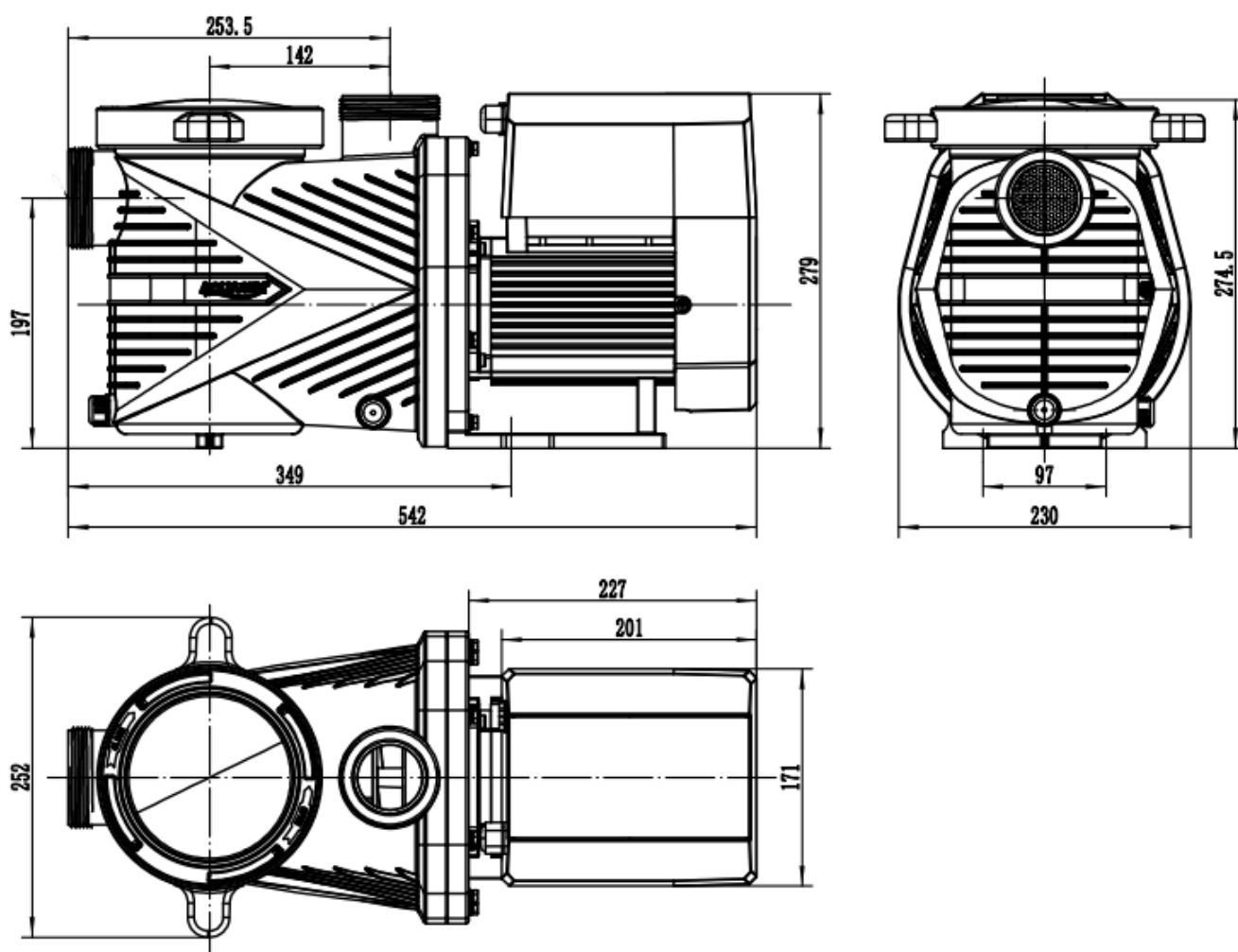

3.2: TECHNICAL DATA

Model	NPE550	NPE750	NPE1500	NPE2000	NPE2500
Input Power (kW)	0.66	0.80	1.10	1.50	1.80
Input Power (hp)	0.88	1.10	1.50	2.00	2.40
Voltage (V/Hz)	220-240 / 50/60				
Current (A)	2.9	3.6	5	6.5	TBA
Maximum Flow Rate (L/min)	350	383	450	517	667
Flow Rate @ 8m Head (L/min)	250	317	417	500	600
Flow Rate @ 10m Head (L/min)	183	242	333	467	533
Noise Level @ 30% Running Speed (dB)	36.0	37.6	38.3	39	TBA
Dimensions (mm)	590 x 255 x 325				
Net Weight (kg)	11.6	11.6	12	13	TBA
Gross Weight (kg)	13.6	13.6	14	15	TBA

3.3: OPERATING CONDITIONS

Ambient temperature	Indoor installation, pump is intended for continuous operation in the temperature range of -10 – 42°C
Water temperature	5°C – 50°C
Humidity	≤90% RH, (20°C ± 2°C)
Altitude	Do not exceed 1,000m above sea level
Installation	The pump can be installed max. 2m above water level
Protection	Class F, IP55

SECTION 4: INSTALLATION

4.1: PUMP LOCATION

1. Install the pump as close to the pool as possible. To reduce friction loss and improve efficiency, use short, direct suction and return piping.
2. To avoid direct sunshine, heat or rain, it is recommended to place the pump indoors or in the shade.
3. DO NOT install the pump in a damp or non-ventilated location. Keep pump and motor at least 150mm away from obstacles. Pump motors require free circulation of air for cooling.
4. The pump should be installed horizontally and fixed with screws to prevent unnecessary noise and vibration.
5. Your pump may have an earthing cable fitted to the motor. Australian standards currently do not require this cable to be connected.

4.2: PLUMBING THE POOL PUMP

1. For optimisation of the pool plumbing, it is recommended to use 50mm PVC pressure pipe. When installing the inlet and outlet fittings, use special sealant for PVC material.
2. The dimensions of the suction line should be the same or larger than the inlet line diameter, to avoid the pump sucking air, which will affect the pump's efficiency.
3. Plumbing on the suction side of the pump should be as short as possible.
4. For most installations we recommend installing a valve on both the pump suction and return lines, which is more convenient for routine maintenance. However, we also recommend that a valve, elbow, or tee installed on the suction line should be no closer to the front of the pump than seven times the suction line diameter.
5. The pump outlet piping system should be equipped with a check valve to prevent the pump from the impact of medium recirculation and water hammer.

4.3: VALVES & FITTINGS

1. Elbows should be no closer than 350mm to the inlet. Do not install 90° elbows directly into the pump inlet/outlet. Joints must be tight.
2. Flooded suction systems should have gate valves installed on suction and return line for maintenance. The suction gate valve should be no closer than seven times the suction pipe diameter as described in this section.
3. Use a check valve in the return line where there is a significant height between the return line and the outlet of the pump.
4. Be sure to install check valves when plumbing in parallel with other pumps. This helps prevent reverse rotation of the impeller and motor.

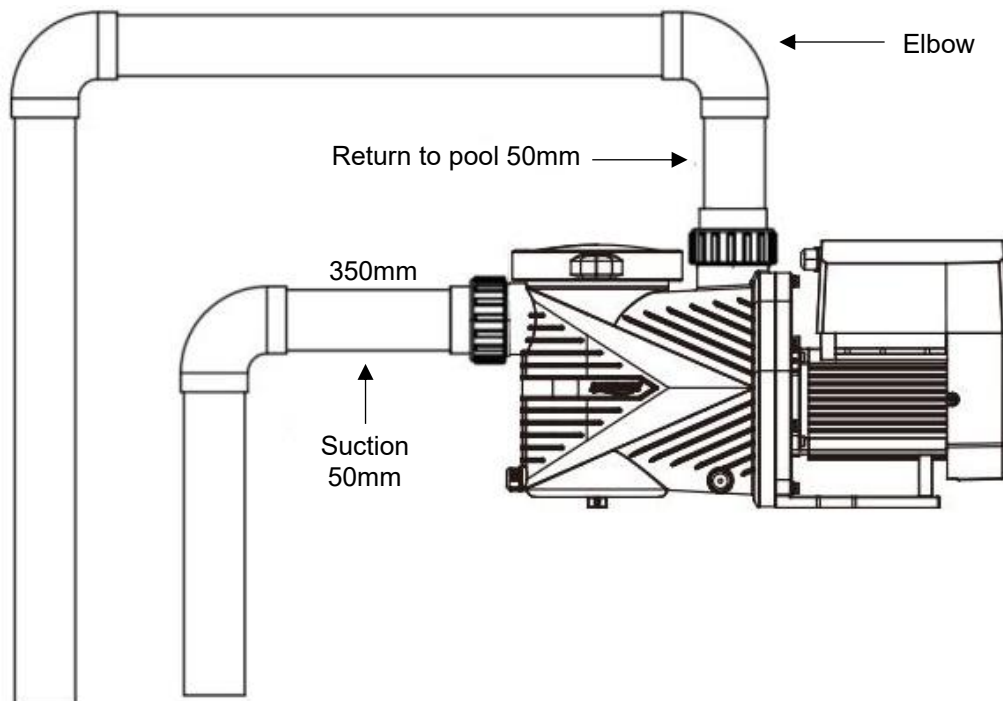

SECTION 5: TOUCHPAD OVERVIEW

	① Running capacity / power display
	② Running capacity / power indicator
	③ Timer indicator 1/2/3/4
	Backwash / unlock
	Up / down: to change the value of the setting
Timer setting / power reading	
On/off	

SECTION 6: START-UP AND OPERATION OF THE PUMP

Check all wirings and plumbing carefully before turning on the pool pump.

6.1: PRE-STARTUP INSPECTION

1. Ensure the pump shaft rotates freely.
2. Ensure the power supply voltage and frequency conform to the nameplate.
3. Facing the fan blade, the direction of motor rotation should be clockwise.
4. Check all wirings and plumbing are installed correctly.
5. Do not to run the pump without water.

6.2: STARTUP

1. Press and hold for more than 3 seconds to unlock the screen.
2. Press to start up the pump.

When the power is switched on, the screen will light up for 3 seconds, the device code will be displayed, and then it will enter the normal working state.

When the screen is locked, only the button will light up.

Press and hold for more than 3 seconds to unlock the screen.

The screen will automatically lock when there is no operation for more than 1 minute. The brightness of the screen will be reduced to 1/3 of the normal display.



Short press to wake up the screen and observe the relevant operating parameters.

6.3: SELF-PRIMING

Each time the pump is started, it will start self-priming.

1. The pump will start counting down from 1,500 seconds. When the system detects the pump is full of water, it will stop counting down and exit priming automatically.
2. To exit self-priming manually, press  for more than 3 seconds. Ensure the pump is full of water before exiting the self-priming process.

NOTE:

- The pump is delivered with self-priming enabled. Each time the pump restarts, it will perform self-priming automatically. To disable the default self-priming function, enter the parameter settings (see Section 6.9).
- If the default self-priming function is disabled, and the pump has not been used for an extended period of time, the water level in the pump basket may drop. To manually activate the self-priming function, press both   for 3 seconds. The adjustable period is from 600 seconds to 1,500 seconds.
- After the manual self-priming is completed, the pump will return to the previous running state.
- To exit the manual self-priming process, press  for more than 3 seconds.

6.4: SELF-CHECKING



After the pump has performed the self-priming process, the pump will recheck for 30 seconds again to make sure the self-priming is completed.

6.5: PUMP RUNNING

The pump will then run at 80% of the running capacity at the initial startup after the self-priming process.

6.6: BACKWASH









To start the backwash or fast re-circulation in any running state, press .

	Default	Setting Range
Time	180 sec	Press  or  to adjust from 0 to 1,500 seconds, in increments of 30 seconds.
Running Capacity	100%	80-100%. Adjust the backwash running capacity in the parameter settings (see section 6.9).

To exit the backwash mode, hold  for 3 seconds. The pump will return to the previous running state.



6.7: RUNNING CAPACITY SETTINGS

















	Hold  for more than 3 seconds to unlock the screen.
	Press  to start. The pump will run at 80% of the running capacity at the initial startup after the self-priming process.
	Press  or  to set the running capacity between 30%-100%, in increments of 5%.
	Hold  for more than 3 seconds to read the real-time power. It will return to the running capacity display after 10 seconds without operation.

NOTE:







- When the running capacity is adjusted, the system will save the latest parameter automatically.
- When setting 100% speed, the pump will increase the speed automatically if the pipeline resistance is high, but will not exceed the rated power of each model.

6.8: TIMER MODE











The pump has 4 separate timers to program the pump's on/off and running capacity.

1	Press  to enter the timer settings.
2	Press  or  to set the local time. Press  to confirm and move to timer-1 setting.
3	When enter the timer-1 setting, the timer indicator 1 will light up. "StA" will be shown on the screen. Press  to proceed and then press  or  to set the start time of timer-1 (in 30 minute increments). Press  to confirm.
4	When the start time of timer-1 is confirmed, "End" will be shown on the screen. Press  to proceed and then press  or  to set the end time of timer-1 (in 30 minute increments), press  to confirm.
5	When the end time of timer-1 is confirmed, "SPd" will be shown on the screen. Press  to proceed and then press  or  to set the running capacity of timer-1 (30% - 100%, in 5% increments). Press  to confirm.
6	When the timer-1 setting is completed, repeat steps 3 – 5 to complete the setting of timers 2, 3 and 4.

NOTES:







- When timer mode is activated, if the set time period contains the current time, the pump will start running according to the set running capacity. The corresponding timer indicator (1 or 2 or 3 or 4) will stay on, and the set running capacity will be shown on the screen.
- If the set time period does not contain the current time, the timer indicator (1 or 2 or 3 or 4) that is about to start running will light up and flash, and the current time will be shown on the screen.
- To return to the previous setting during the timer setting, hold both   for 3 seconds.
- If 4 timers are not required, hold  for 3 seconds after completing the setting of the specific timer. The system will automatically save the current set value and activate the timer mode.
- To check the setting of each timer when the timer mode is on, press  to select the specific timer (1 or 2 or 3 or 4), and the corresponding timer indicator will light up. Then press  to check the start time, end time, and running capacity setting of the selected timer.
- To read the real-time power, hold  for 3 seconds. It will return to the timer display after 10 seconds without operation.
- To exit the timer mode, hold  for 3 seconds.

6.9: PARAMETER SETTINGS

Restore factory setting	Under OFF mode, hold both   for 3 seconds
Check the software version	Under OFF mode, hold both   for 3 seconds
Enter the parameter setting	Under OFF mode, hold both   for 3 seconds to enter the parameter setting. The parameter address (on the left) and default setting value (on the right) will flash alternately on the screen. Press  or  to adjust the current value, and hold both   for 3 seconds to the next parameter address. It will exit the parameter setting after 10 seconds without operation.

Parameter Address	Description	Default Setting	Setting Range
1	PIN3	100%	30-100%, in 5% increments
2	PIN2	80%	30-100%, in 5% increments
3	PIN1	40%	30-100%, in 5% increments
4	Backwash capacity	100%	80-100%, in 5% increments
5	Enable or disable self-priming at each startup	25	25: enables 0: disables

EXAMPLE: How to Enable/Disable Self-Priming Function:

1. Enter parameter settings: Under off mode, hold both   for 3 seconds.
2. Select the self-priming parameter address: Hold both   for 3 seconds until you reach Address 5.
3. Enable or disable self-priming at each startup: Adjust by pressing  or , 25= Enables, 0=Disables.

SECTION 7: EXTERNAL CONTROLLER (OPTIONAL)

An external controller can be used via the following contacts.

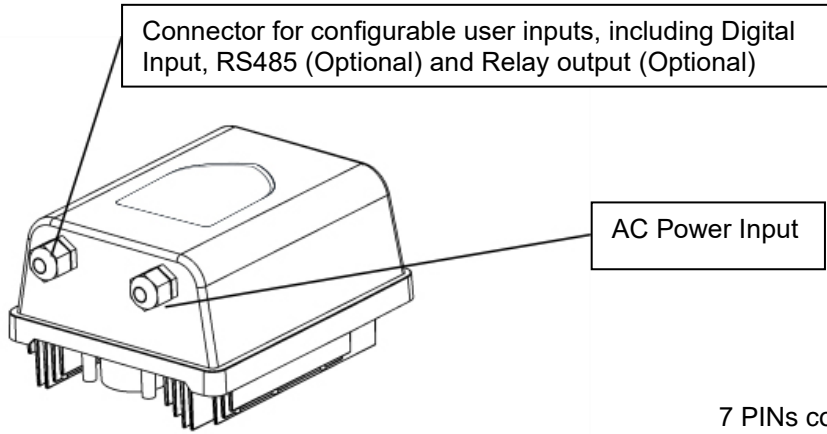

7 PINs connector for Digital Input and RS485 (Optional)

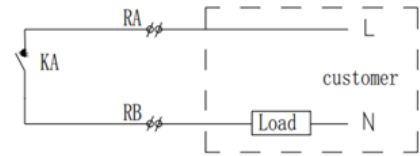
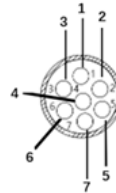
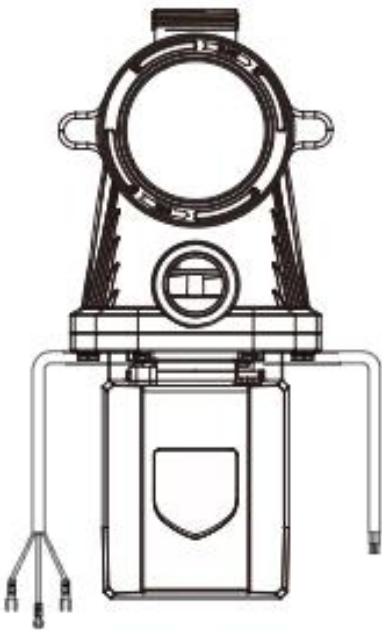

Relay Output (Optional)

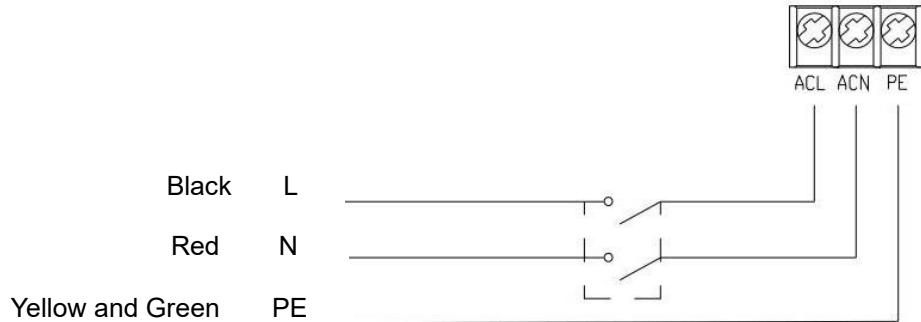

Name	Color	Description
PIN 1	Red	Digital Input 4
PIN 2	Black	Digital Input 3
PIN 3	White	Digital Input 2
PIN 4	Grey	Digital Input 1
PIN 5	Yellow	Digital Ground
PIN 6	Green	RS485 A
PIN 7	Brown	RS485 B

1. Digital Input
 - When PIN4 connects with PIN5, the pump will be mandatory to stop; if disconnected, the digital control will be invalid.
 - When PIN3 connects with PIN5, the pump will be mandatory to run at 100%; if disconnected, the control priority will be back on panel control.
 - When PIN2 connects with PIN5, the pump will be mandatory to run at 80%; if disconnected, the control priority will be back on panel control.
 - When PIN1 connects with PIN5, the pump will be mandatory to run at 40%; if disconnected, the control priority will be back on panel control.
 - The capacity of inputs (PIN1/PIN2/PIN3) could be modified according to the parameter setting.
2. RS485
 - To connect with PIN6 and PIN7, the pump could be controlled via Modbus 485 communication protocol.

SECTION 8: MAINTENANCE

Empty the pump basket frequently. The basket should be inspected through the transparent lid and emptied when there is debris inside. The following instructions should be followed:

1. Disconnect the power supply.
2. Unscrew the pump lid anti-clockwise and remove.
3. Lift up the pump basket.
4. Empty the debris from the basket and rinse out the debris if necessary.
NOTE: Do not knock the plastic basket on a hard surface as it will cause damage.
5. Inspect the basket for signs of damage and replace if required.
6. Check the Pump Lid O-Ring for stretching, tears, cracks or any other damage.
7. Replace the pump lid, hand tightening is sufficient.

NOTE: Periodically inspecting and cleaning the pump basket will help prolong the life of your pump.

SECTION 9: PROTECTION MANAGEMENT

9.1: High-Temperature Warning and Speed Reduction

During normal operation (except backwash/self-priming), when the module temperature reaches the high-temperature warning trigger threshold (81°C), it enters the high-temperature warning state; when the temperature drops to the high-temperature warning release threshold (78°C), the high-temperature warning state is released. The display area alternately displays AL01 and running speed.

If AL01 is displayed for the first time, the running capacity will be automatically reduced as below:

1. If current operating capacity is higher than 85%, the running capacity will be automatically reduced by 15%.
2. If current operating capacity is higher than 70%, the running capacity will be automatically reduced by 10%.
3. If current operating capacity is lower than 70%, the running capacity will be automatically reduced by 5%.

9.2: Under-Voltage Protection

When the device detects that the input voltage is less than 198V, the device will limit the current running speed. The display area alternately displays AL02 and running speed.

1. When input voltage is less than or equal to 180V, the running capacity will be limited to 70%.
2. When the input voltage range is within 180V - 190V, the running capacity will be limited to 75%.
3. When the input voltage range is within 190V - 198V, the running capacity will be limited to 85%.



SECTION 10: TROUBLESHOOTING

Problem	Possible causes and solution
Pump does not start	<ul style="list-style-type: none"> • Power supply fault, disconnected or defective wiring. • Fuses blown or thermal overload open. • Check the rotation of the motor shaft for free movement and lack of obstruction. • If pump has been unused for an extended period of time, unplug the power supply and manually rotate the motor's rear shaft a few times with a screwdriver.
Pump does not prime	<ul style="list-style-type: none"> • Empty pump basket. Make sure the pump housing is filled with water and the Pump Lid O-Ring is clean. • Loose connections on the suction side. • Pump basket or skimmer basket loaded with debris. • Suction side clogged. • Distance between pump inlet and water level is higher than 2m, the installation height of pump should be lowered.
Low water flow	<ul style="list-style-type: none"> • Pump does not prime. • Air entering suction piping. • Pump basket full of debris. • Inadequate water level in pool.
Pump being noisy	<ul style="list-style-type: none"> • Air leak in suction piping, cavitation caused by restricted or undersized suction line or leak at any joint, low water level in pool, and unrestricted discharge return lines. • Vibration caused by improper installation, etc. • Damaged motor bearing or impeller (contact your supplier for repair).

When the device detects a failure, it will stop automatically and display an error code. After stopping for 15 seconds, check if the failure is cleared. If cleared, the pump will resume working.

Item	Error Code	Details	
1	E001	Description	Abnormal input voltage: the power supply voltage is out of the range of 165V to 275V.
		Process	The pump will stop automatically for 15 sec and resume working if it detects the power supply voltage is within the range.
2	E002	Description	Output over current: The peak current of the pump is higher than the protection current.
		Process	The pump will stop automatically for 15 sec and then resume working, if this occurs for thrice continuously, the pump will shut down and need to be checked and restarted manually.
3	E101	Description	Heat sink overheat: The heat sink temperature reaches 91°C for 10sec.
		Process	The pump will stop automatically for 30 sec and resume working if it detects the heat sink temperature is less than 81°C.
4	E102	Description	Heat sink sensor error: The heat sink sensor detects an open or short circuit.
		Process	The pump will stop automatically for 15 sec and resume working if it detects the heat sink sensor is not open or short circuit.
5	E103	Description	Master driver board error: The Master driver board is faulty.
		Process	Same process as E002.
6	E104	Description	Phase-deficient protection: Motor cables are not plugged into the master drive board.
		Process	Same process as E002.
7	E105	Description	AC current sampling circuit failure: When the pump power off, the bias voltage of the sampling circuit is out of the range of 2.4V~2.6V.
		Process	The pump needs to be powered off and restarted manually.
8	E106	Description	DC abnormal voltage: The DC voltage is out of the range of 210V to 420V.
		Process	Same process as E002.

Item	Error Code	Details	
9	E107	Description	PFC protection: PFC protection occurs on the Master driver board.
		Process	Same process as E002.
10	E108	Description	Motor power overload: Motor power exceeds the rated power by 1.2 times.
		Process	Same process as E002.
11	E201	Description	Circuit board error: When the pump power off, the bias voltage of the sampling circuit is out of the range of 2.4V~2.6V.
		Process	The pump needs to be powered off and restarted manually.
12	E203	Description	RTC time reading error: Reading and writing the information of timer clock is incorrect.
		Process	The pump needs to be powered off and restarted manually.
13	E204	Description	Display Board EEPROM reading failure: Reading and writing the information of display board EEPROM is incorrect.
		Process	The pump needs to be powered off and restarted manually.
14	E205	Description	Communication Error: The communication between display board and master driver board is failure lasts 15 sec.
		Process	The pump will stop automatically for 15 sec and resume working if it detects the communication between display board and master driver board lasts 1 sec.
15	E207	Description	No water protection: The pump is lack of water.
		Process	Stop the pump manually, fill up the pump with water and restart it. If this occurs for twice continuously, the pump will shut down and need to be checked manually.
16	E209	Description	Loss of prime: The pump cannot self-priming due to the reasons such as exceeding the suction range or the pipeline is too complicated.
		Process	Check the pump or pipeline that there is no leakage, and then fill up the pump with water and restart it.

SECTION 11: SCHEMATICS

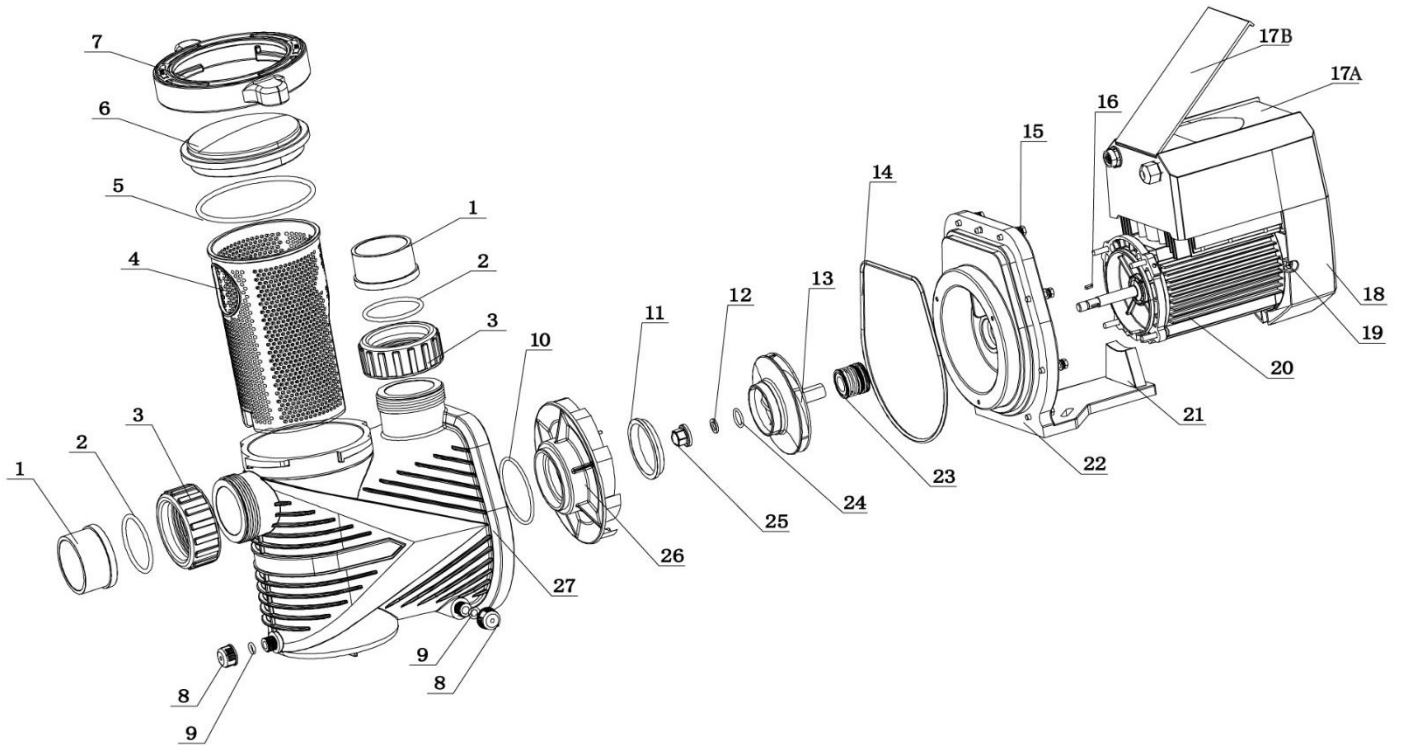

Ref #	Stock Code	DESCRIPTION	QTY
1, 2 & 3	NPEP001	Union Tail, Union O-Ring & Union Nut	Set
4	SBN2	Pump Basket	1
5	OR951M	Pump Lid O-Ring	1
6	LD016	Pump Lid (Transparent)	1
7	NPEP002	Lid Locking Nut	1
8	NPEP003	Drain Plug	2
9	OR952M	Drain Plug O-Ring	2
10	OR953M	Diffuser O-Ring	1
11	TBA	Turnable Return Ring	1
12	TBA	Spring Washer	1
13	NPEP030	Impeller suits NPE550 & NPE750	1
13	NPEP031	Impeller suits NPE1500	1
13	NPEP032	Impeller suits NPE2000	1
14	GAS680	Pump Body Gasket	1
15	TBA	Backplate Bolt	8
16	TBA	Parallel Key	1
17A	NPEP051	Inverter Controller w/ DI suits NPE550	1
17A	NPEP052	Inverter Controller w/ DI suits NPE750	1
17A	NPEP053	Inverter Controller w/ DI suits NPE1500	1
17A	NPEP054	Inverter Controller w/ DI suits NPE2000	1
17B	TBA	Inverter Controller Cover	1
18	NPEP008	Fan Cover	1
19	TBA	Fan Cover Screw	3
20	NPEP060	Pump Motor suits NPE550 & NPE750	1
20	TBA	Pump Motor suits NPE1500	1
20	TBA	Pump Motor suits NPE2000	1
21	TBA	Motor Base	1
22	NPEP011	Backplate	1
23	MC30	Mechanical Seal	1
24	OR954M	Impeller O-Ring	1
25	TBA	Impeller Nut	1
26	TBA	Diffuser	1
27	NPEP014	Pump Body	1
-	NPEP015	Pump Body Decorative Ribbon Decal	1
-	NPEP016	Controller Housing w/ Tempered Glass	1
-	NPEP018	Display Board suits NPE550	1
-	NPEP019	Display Board suits NPE750	1
-	NPEP020	Display Board suits NPE1500	1
-	NPEP021	Display Board suits NPE2000	1



SECTION 12: DISPOSAL

When disposing of the product, please sort the waste products as electrical or electronic product waste, or hand it over to the local waste collection system.

The separate collection and recycling of waste equipment at the time of disposal will help ensure that it is recycled in a manner that protects human health and the environment. Contact your local authority for information on where you can drop off your water pump for recycling.

SECTION 13: WARRANTY AND PRODUCT REGISTRATION

Please register your product online at www.poolpro.com.au/product-registration.

- The limited warranty for the Neptune X-Eco Inverter Pool Pump (models NPE550, NPE750, NPE1500, NPE2000 & NPE2500) covers manufacturer's defects in materials and workmanship for 3 years on all parts and labour.
If the pool pump is installed in a commercial setting, the warranty period is 1 year on all parts and labour.
- The warranty is only valid for the original purchaser and is non-transferable.
- Adverse operating conditions beyond the control of the manufacturer such as improper voltage, excessive ambient temperature or any condition that adversely affects the performance of the equipment will render this warranty null and void.
- Defective equipment must be returned to the authorised dealer as soon as the purchaser becomes aware of the defect and all transport costs must be prepaid.
- Neither the manufacturer nor the authorised dealer shall be responsible for any goods damaged in transit.
- Any liability of the manufacturer pursuant to the Trade Practices Act 1974, as amended for a breach of a condition or warranty shall be limited to replacing or acquiring the equipment (or part thereof) where the same has been supplied.
- The maximum liability incurred by the manufacturer shall not in any case exceed the contract price for the equipment or the product parts or components thereof claimed to be defective. Further, the manufacturer shall not be liable for any loss, damage or delay directly or indirectly caused by any malfunction of or defect of or failure of the equipment other than as expressly provided in this warranty.
- The manufacturer and authorised dealer will not be held liable for damage caused to the pool and surrounding areas.
- Keep your original purchase invoice and serial number in a safe place.

Warranty is void under the following circumstances:

- Incorrect operation of the unit by not following correct instructions.
- Foreign matter blocking impeller or restricting water flow.
- Incorrect installation, including inadequate ventilation.
- Improper maintenance and balancing of pool water.
- Damage caused to the pool pump due to misuse or damage caused by any other means than manufacturer defect.
- If the pool pump is repaired or serviced by an unauthorised dealer or serviceman.
- If a fault occurs in the operation of the pool pump by using non-genuine parts/accessories.
- If the pool pump has been misused, neglected, damaged or altered in any way, including running the pump without sufficient water flow, lightning strikes, flooding or incorrect power supply.
- General wear and tear of consumable products.

To submit a warranty request, visit www.poolpro.com.au/serviceclaim



